



GUIDELINES FOR INSTALLING FLOATING MODULAR CUBE STABILIZERS FOR STANDALONE BOAT LIFTS

PARTS REQUIRED

1. SPMP FLOATING MODULAR CUBE STABILIZERS (1)
*Note: Modular Cube Stabilizers are available in 8", 10", 12", & 14" sizes to accommodate different pile sizes.
2. FLOATING MODULAR CUBES – QUANTITY WILL DEPEND ON THE SIZE OF BOAT LIFT REQUIRED. COORDINATE WITH MANUFACTURER OF FLOATING MODULAR CUDE BOAT LIFT.
3. PILES (1) – SIZE AND LENGTH DEPENDS ON LOCATION CONDITIONS

GUIDELINES

1. The Modular Cube Stabilizers (Figure 1) are meant to be installed in place of a modular cube of the boat lift.
2. Install Modular Cube Stabilizer(s) in boat lift. Coordinate location and quantity with modular cube boat lift manufacturer. A minimum of two Modular Cube Stabilizers are required per boat lift.
3. Modular Cube Stabilizer can be installed over an existing pile or a new pile can be driven through it. See Figure 2 &3.
4. For shallow water applications install the long side of the stabilizer in the up position.
5. For larger lift installations additional stabilizers are recommended. Call SPMP for additional information for custom installations.

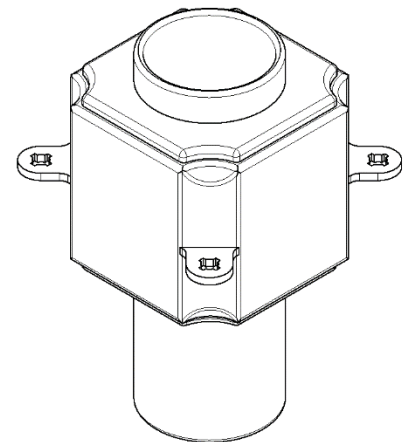

Figure 1 – Modular cube stabilizer

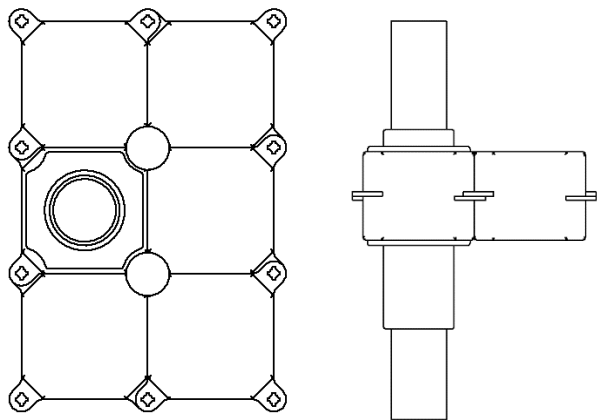

Figure 2

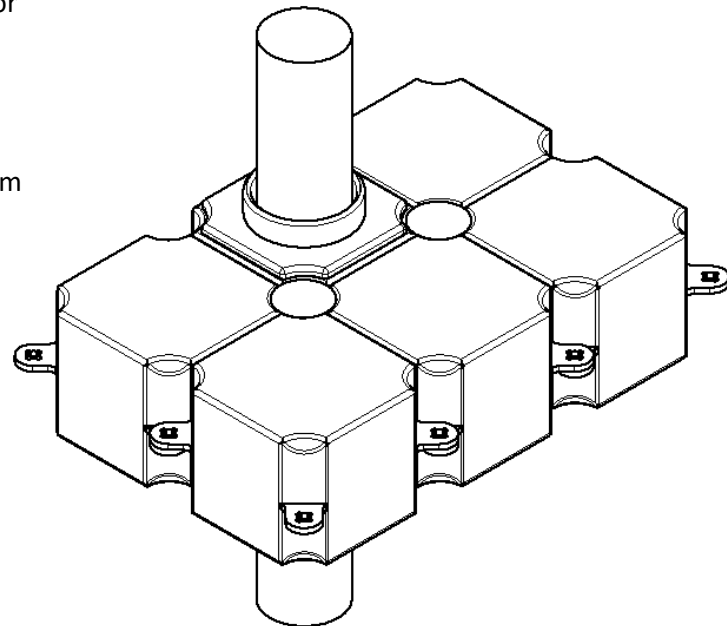

Figure 3

For more information contact:

www.seapowermarineproducts.com

843-884-5656

Patent Numbers

Boat Lifts: US 9,132,897; US 9,352,812; US 9,604,709; US 10,086,919; US 10,370,073

Pile Guides, Slide Guides and Stabilizers: US 10,267,003; US D828,746; US D828,747; US D828,747; US D837,041; US D826,702; 62/851,783; 29/699,280; 29/722,469; 29/723,576; 29/723,579

Floating Platform: 16/794,670

Modular Mooring Systems: US 10,822,063 B1; US D899,902 S

Trademarks :87/442,461; 5,788,367; 88/567,151

Rev. 3- 01/29/21